

Enave 240 P A21

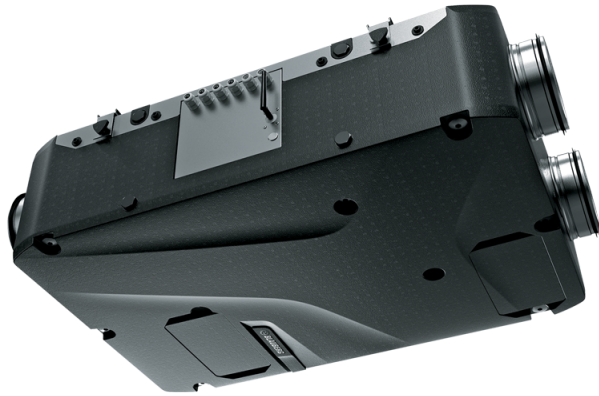

Heat recovery air handling unit in sound- and heat-insulated casing made of expanded polypropylene

- Maximum airflow: 313
- Sound pressure level LpA at 3 m: 35
- Heat exchanger type: Counter flow
- Extract filter: Coarse > 60 % (G4)
- Supply filter: Coarse > 60 % (G4) (option ePM1 60 % (F7))
- Sound insulation
- Motor type: EC
- Bypass: Auto
- Reheater: Optional
- Preheater: Optional
- BMS protocol: ModBus
- Control: Smartphone
- Casing material: EPP
- Humidity sensor: Optional
- CO2 sensor: Optional
- VOC sensor: Optional
- PM2.5 sensor: Optional

	Unit of measurement	Enave 240 P A21
Connected air duct size	mm	160
Phases	-	1
Minimum supply voltage	V	230
Maximum supply voltage	V	230
Power supply frequency	Hz	50/60
Rated power	W	168
Unit current	A	1.3
Maximum airflow	m ³ /h	313
Sound pressure level LpA at 3 m	dB(A)	35
Heat recovery efficiency, max	%	90
Heat exchanger type	-	Counter flow
Heat exchanger material	-	Polystyrene
Weight	kg	13
Extract filter	-	Coarse > 60 % (G4)
Supply filter	-	Coarse > 60 % (G4) (option ePM1 60 % (F7))
Transported air temperature (max)	°C	45
Ambient air temperature min	°C	1
Ambient air temperature max	°C	40
Ambient air humidity max	%	60
Ingress protection rating	-	IP22

Ingress protection rating of the drive	-	IP44
--	---	------

Dimensions

H	W	L	D	W1	L1
272	640	930	160	300	627

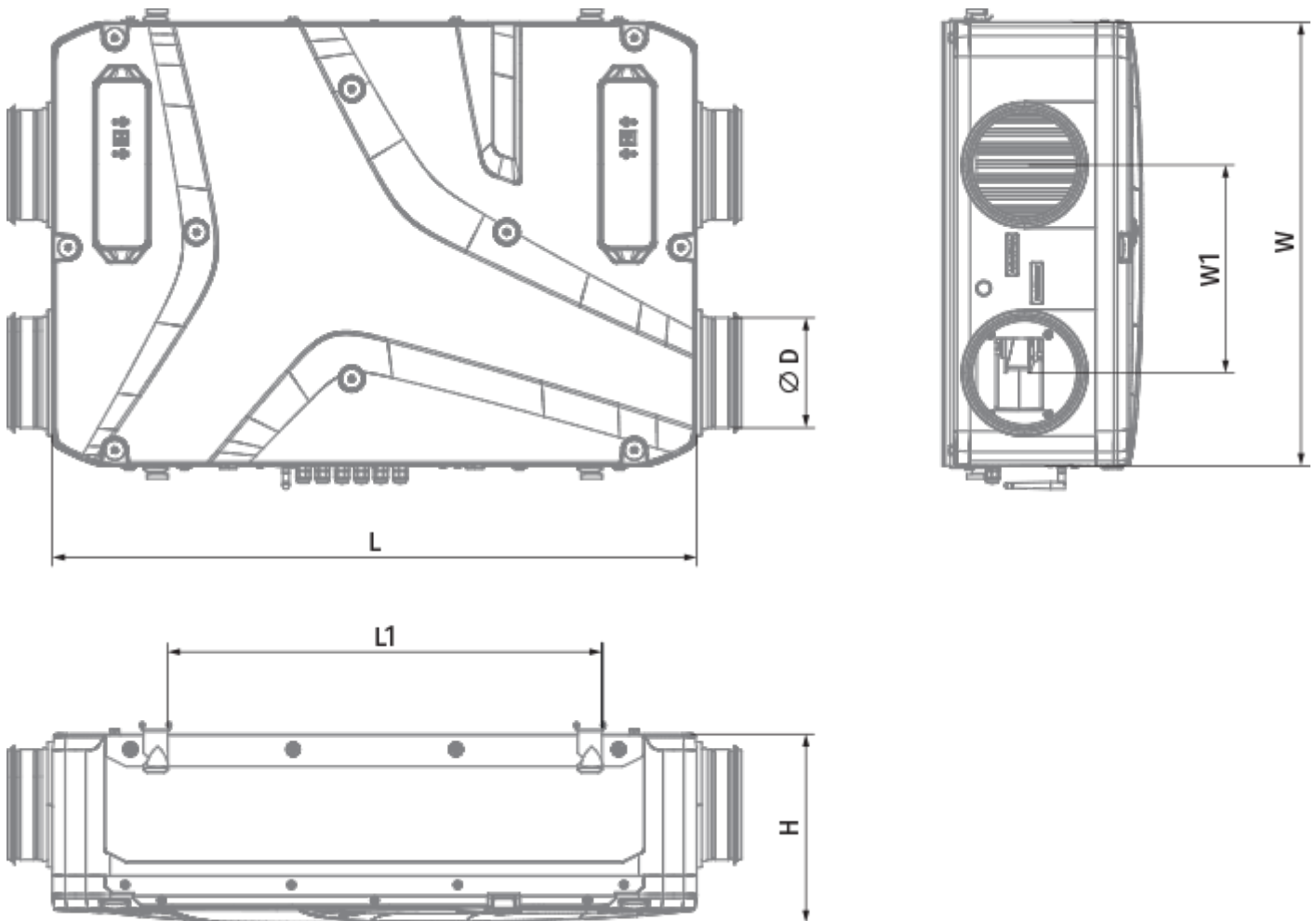



Accessories





Other accessories

Name	Photo	Description
SF 205x200x48 Coarse 90% G4		Panel filter G4
SF 205x200x48 ePM1 60% F7		F7 panel filter





Control Panels for AHU





Name	Photo	Description
A25		The control panel with a sensor display
A22		The A22/A22 WiFi control panels are used for control of industrial and domestic air handling units with an A21 automation system.
A22 WiFi		The A22/A22 WiFi control panels are used for control of industrial and domestic air handling units with an A21 automation system.

Sensors

Name	Photo	Description
HV2		Humidity sensor
CO2-3		CO2 sensor
CO2-1		CO2 sensors
CO2-2		CO2 sensors
HR-S		Electro-mechanical humidistats

Electrical heaters



Name	Photo	Description
NKP 160-0,8-1 A21 V.2		Heater for heat exchanger freeze protection
NKP 160-1,2-1 A21 V.2		Heater for heat exchanger freeze protection
NKP 160-1,7-1 A21 V.2		Heater for heat exchanger freeze protection
NKP 160-2,0-1 A21 V.2		Heater for heat exchanger freeze protection

NKD 160-0,8-1 A21 V.2		Duct heater for supply air post-heating with external control
NKD 160-1,2-1 A21 V.2		Duct heater for supply air post-heating with external control
NKD 160-1,7-1 A21 V.2		Duct heater for supply air post-heating with external control
NKD 160-2,0-1 A21 V.2		Duct heater for supply air post-heating with external control

Condensation drainage

Name	Photo	Description
SH-32		The hydraulic U-trap for condensate drainage from heat exchangers and coolers in ventilation and air conditioning systems

For round ducts

Name	Photo	Description
SR 160/600		Silencer is applied for noise absorption produced during the ventilating equipment operation and spread along the ducting systems
SR 160/900		Silencer is applied for noise absorption produced during the ventilating equipment operation and spread along the ducting systems
SR 160/1200		Silencer is applied for noise absorption produced during the ventilating equipment operation and spread along the ducting systems

For round ducts

Name	Photo	Description
KRV 160		Air damper for air flow cut-off in round air ducts

Electric actuators

Name	Photo	Description
Belimo TF230		The actuators are designed for controlling air dampers with cross section up to 0.4 m ² performing protection functions