

# Enave-T 181 P A21

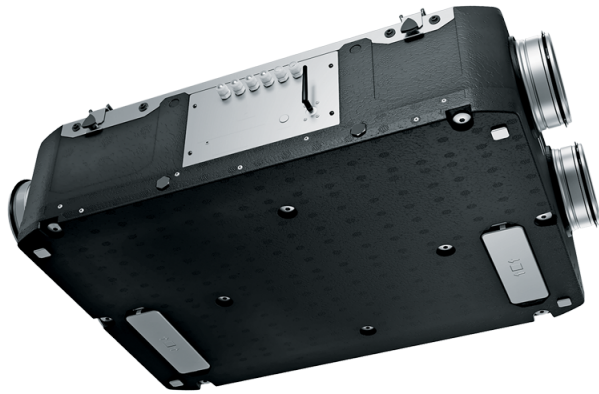

Heat recovery air handling unit in sound- and heat-insulated casing made of expanded polypropylene

- Maximum airflow: 191
- Sound pressure level LpA at 3 m: 34
- Heat exchanger type: Counter flow
- Extract filter: Coarse > 60 % (G4)
- Supply filter: Coarse > 60 % (G4) (option ePM1 60 % (F7))
- Sound insulation
- Motor type: EC
- Enthalpy heat exchanger
- Bypass: Auto
- Reheater: Optional
- Preheater: Optional
- BMS protocol: ModBus
- Control: Smartphone
- Casing material: EPP
- Humidity sensor: Optional
- CO2 sensor: Optional
- VOC sensor: Optional
- PM2.5 sensor: Optional

	Unit of measurement	Enave-T 181 P A21
Connected air duct size	mm	160
Phases	-	1
Minimum supply voltage	V	230
Maximum supply voltage	V	230
Power supply frequency	Hz	50/60
Rated power	W	54
Power of electrical preheater	W	0
Unit current	A	0.46
Maximum airflow	m <sup>3</sup> /h	191
Sound pressure level LpA at 3 m	dB(A)	34
Heat recovery efficiency, max	%	82
Heat exchanger type	-	Counter flow
Heat exchanger material	-	Enthalpy
Weight	kg	15
Extract filter	-	Coarse > 60 % (G4)
Supply filter	-	Coarse > 60 % (G4) (option ePM1 60 % (F7))
Transported air temperature (max)	°C	45
Ambient air temperature min	°C	1
Ambient air temperature max	°C	40
Ambient air humidity max	%	60
Ingress protection rating	-	IP22

Ingress protection rating of the drive	-	IP44
--	---	------

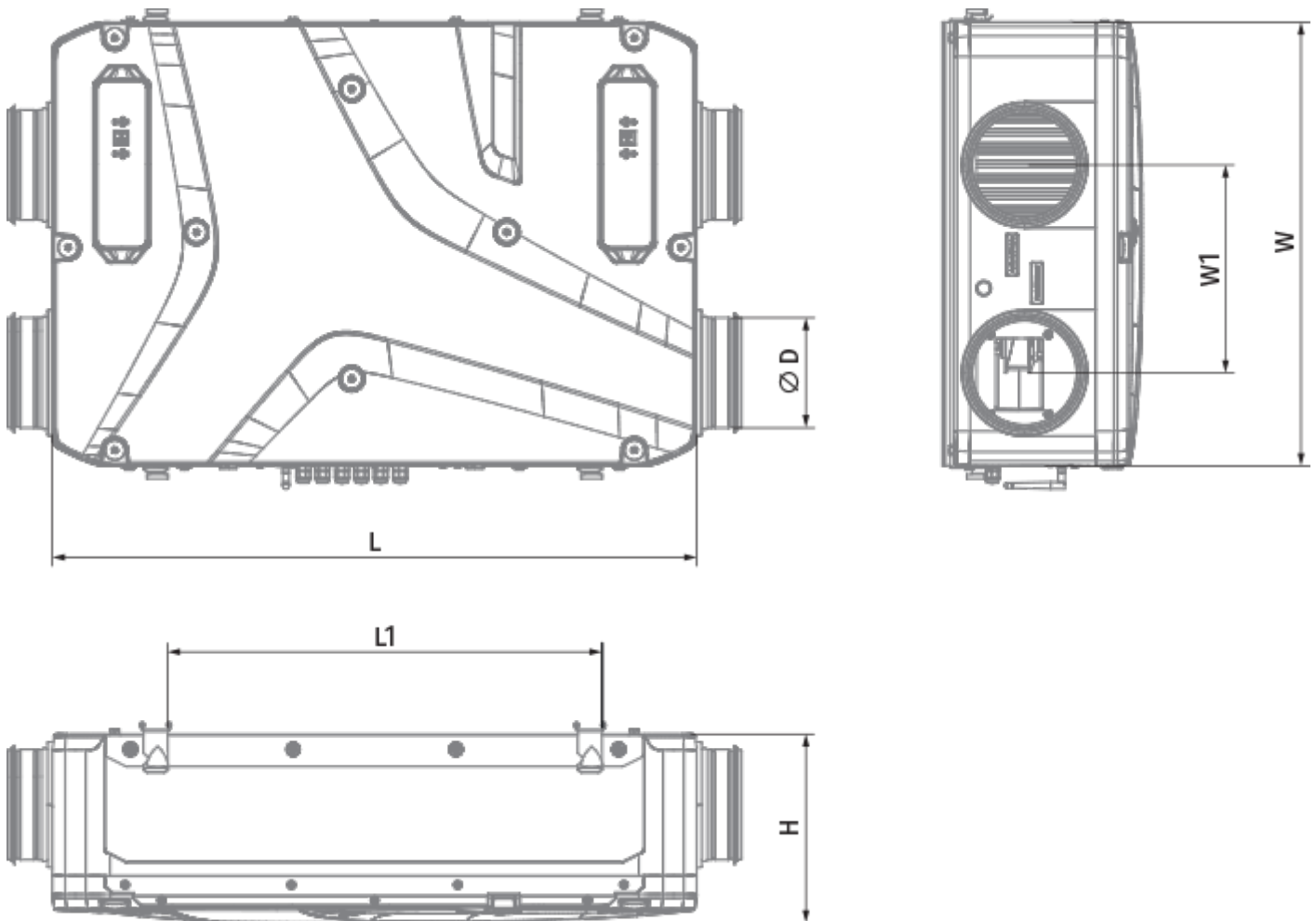

## Dimensions

H	W	L	D	W1	L1
272	640	930	160	300	627





## Accessories



### Other accessories

Name	Photo	Description
SF 205x200x48 Coarse 90% G4		Panel filter G4
SF 205x200x48 ePM1 60% F7		F7 panel filter





### Cooker Hoods

Name	Photo	Description
<a href="#">PD-Enave 181 P</a>		Decorative panel
<a href="#">PD-Enave 181 P</a>		Decorative panel

### Control Panels for AHU

Name	Photo	Description
<a href="#">A25</a>		The control panel with a sensor display
<a href="#">A22</a>		The A22/A22 WiFi control panels are used for control of industrial and domestic air handling units with an A21 automation system.
<a href="#">A22 WiFi</a>		The A22/A22 WiFi control panels are used for control of industrial and domestic air handling units with an A21 automation system.

### Sensors

Name	Photo	Description
<a href="#">HV2</a>		Humidity sensor
<a href="#">CO2-3</a>		CO2 sensor
<a href="#">CO2-1</a>		CO2 sensors
<a href="#">CO2-2</a>		CO2 sensors
<a href="#">HR-S</a>		Electro-mechanical humidistats

### Electrical heaters



Name	Photo	Description
<a href="#">NKP 160-0,8-1 A21 V.2</a>		Heater for heat exchanger freeze protection

<a href="#">NKP 160-1,2-1 A21 V.2</a>		Heater for heat exchanger freeze protection
<a href="#">NKP 160-1,7-1 A21 V.2</a>		Heater for heat exchanger freeze protection
<a href="#">NKP 160-2,0-1 A21 V.2</a>		Heater for heat exchanger freeze protection
<a href="#">NKD 160-0,8-1 A21 V.2</a>		Duct heater for supply air post-heating with external control
<a href="#">NKD 160-1,2-1 A21 V.2</a>		Duct heater for supply air post-heating with external control
<a href="#">NKD 160-1,7-1 A21 V.2</a>		Duct heater for supply air post-heating with external control
<a href="#">NKD 160-2,0-1 A21 V.2</a>		Duct heater for supply air post-heating with external control

### Condensation drainage

Name	Photo	Description
<a href="#">SH-32</a>		The hydraulic U-trap for condensate drainage from heat exchangers and coolers in ventilation and air conditioning systems

### For round ducts

Name	Photo	Description
<a href="#">SR 160/600</a>		Silencer is applied for noise absorption produced during the ventilating equipment operation and spread along the ducting systems
<a href="#">SR 160/900</a>		Silencer is applied for noise absorption produced during the ventilating equipment operation and spread along the ducting systems
<a href="#">SR 160/1200</a>		Silencer is applied for noise absorption produced during the ventilating equipment operation and spread along the ducting systems

### For round ducts

Name	Photo	Description
------	-------	-------------

<a href="#">KRV 160</a>		Air damper for air flow cut-off in round air ducts
-------------------------	---	--

### Electric actuators

Name	Photo	Description
<a href="#">Belimo TF230</a>		The actuators are designed for controlling air dampers with cross section up to 0.4 m <sup>2</sup> performing protection functions